

# PIANEROTTOLI IN LAMIERA STIRATA

## GRIGLIE IN LAMIERA STIRATA E CONTROTELAI

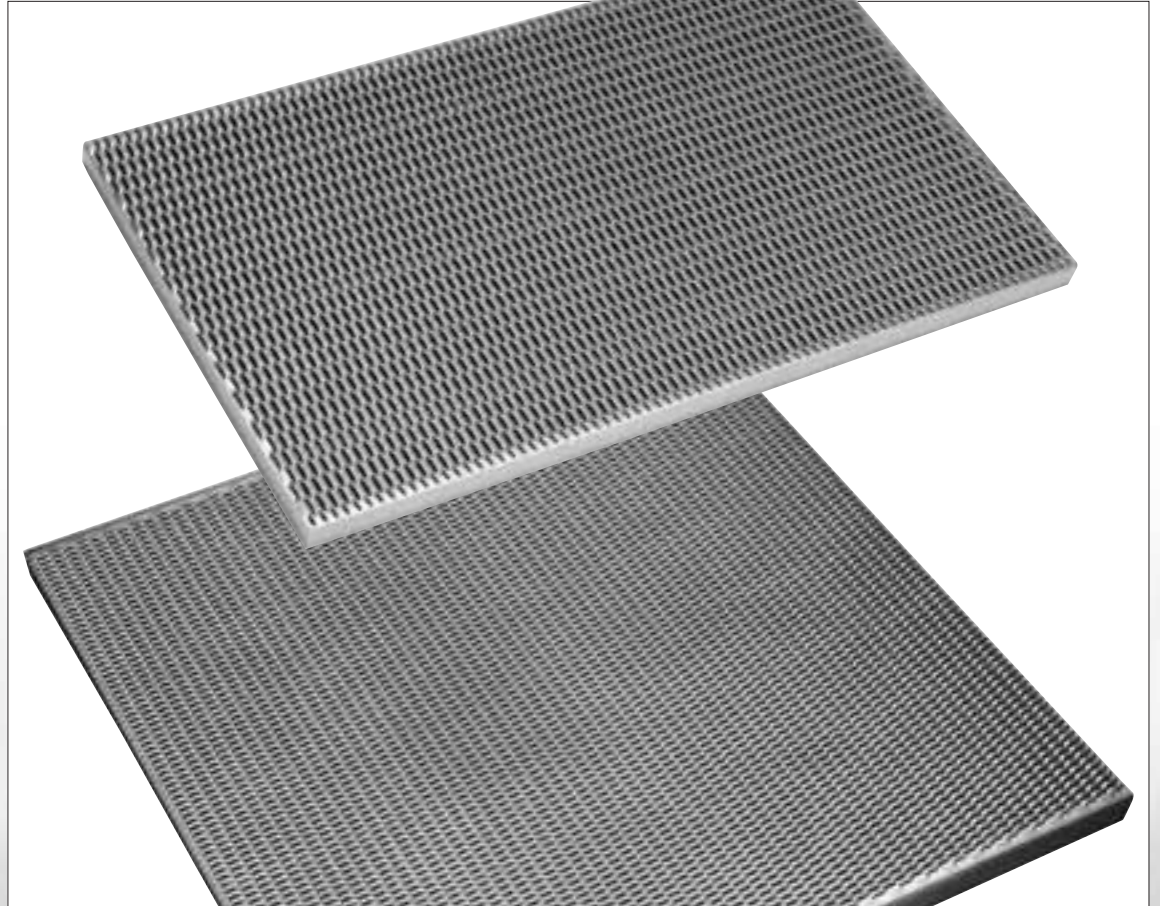

**FILS 1** • 110 x 40 (25,4) - 7 x 4 mm - 17 kg/m<sup>2</sup>



**FILS 21** • 45 x 15 (13,4) - 5 x 3 mm - 17,5 kg/m<sup>2</sup>

Grigliato Filis 21  
Certificato Antiscivolo R13  
Norma DIN 51130



**FILS 4** • 62,5 x 20 (20) - 7,5 x 4 mm - 23 kg/m<sup>2</sup>

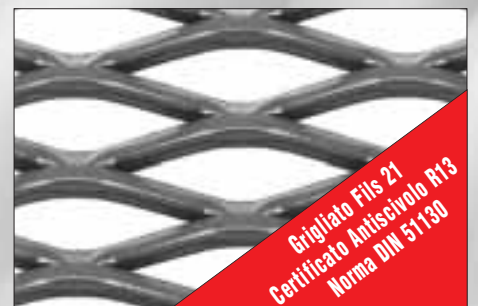

**BETA** • 43 x 10 (13,3) - 3 x 3 mm - 10,5 kg/m<sup>2</sup>

Grigliato Filis 21  
Certificato Antiscivolo R13  
Norma DIN 51130

# PIANEROTTOLI E GRIGLIE

**Si realizzano  
pianerottoli  
e griglie  
su misura**

PIANEROTTOLI	DL mm	DC mm	H mm	Peso kg/cad	Portata kg Concentrati
Per INDUSTRIA FILS 21	800	800	40	23,0	408
	1000	1000	40	37,0	408
Per SICURFILS FILS 21	1200	1200	50	66,0	510
Per ECO Tp.43	800	800	50	16,5	408
	1000	1000	50	27,0	408
Per BETA Tp.43	1200	1200	50	40,0	408
Per GAMMA FILS 20 - sp 2,5	1200	1200	50	40,0	408

GRIGLIE	DL mm	DC mm	H mm	Peso kg/cad	Portata kg Concentrati
FILS 4 - sp 4	400	1000	35	24,0	408
	600	1000	35	33,5	408
	800	1000	35	43,5	408
FILS 21 - sp 3	400	1000	35	21,0	408
	600	1000	35	30,0	408
	800	1000	35	38,5	408
FILS 1 - sp 4	400	1000	35	20,5	408
	600	1000	35	29,5	408
	800	1000	35	38,5	408
Controtelai 38x38x2	410	1010	38	3,2	
	610	1010	38	3,6	
	810	1010	38	4,1	

**Pianerottolo per ECO Tipo 43 sp 3 mm**

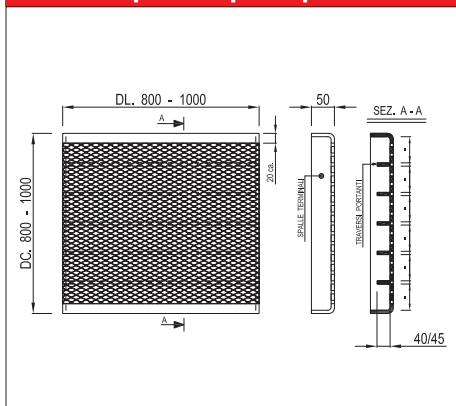

**Pianerottolo per INDUSTRIA FILS 21 sp 3 mm**

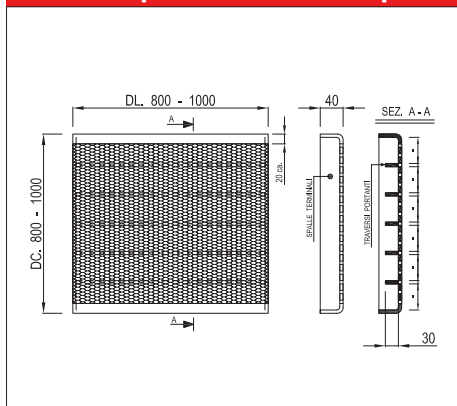

**Pianerottolo per BETA Tipo 43 sp 3 mm**

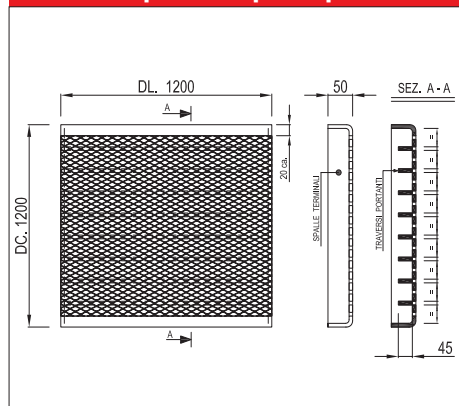

**Pianerottolo per SICURFILS - Fils 21 sp 3 mm**

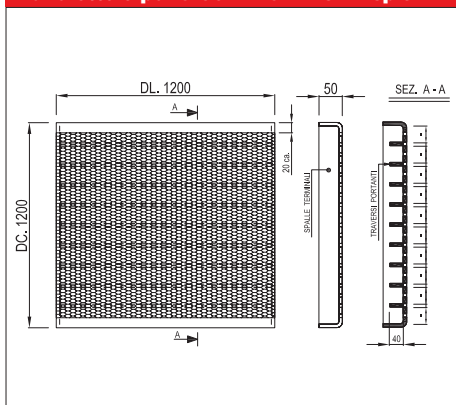

**Pianerottolo per GAMMA FILS 20 sp 2,5 mm**

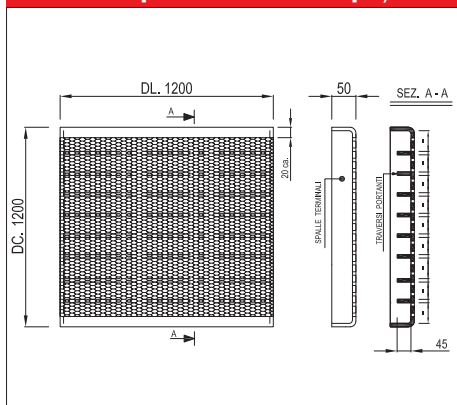

**GRIGLIE**

